

Rechargeable Nickel-Metal-Hydride Button Cells

55608 201 041 1 / V 80 H SC ST

System highlights of Ni-MH Button Cells – Robust Family – from VARTA Microbattery:

- Excellent overcharge capability due to patented GCE-Electrode
- Low self-discharge of 20% at RT after 1 year
- Flat and stable discharge voltage
- Long life – typical 500 full cycles
- Slim design
- Wide temperature range
 - Storage: -40°C up to +65°C
 - Discharge: -20°C up to +65°C
 - Charge: 0°C up to +65°C

Key features:

- Good recovery characteristics after long storage period and deep discharge
- Sealed rechargeable Ni-MH Button Cells from VARTA Microbattery can be operated in any position
- The cells complete the manufacturing process in a charged state
- Because of time and temperature depending self-discharge, the state of charge upon receipt can not be precisely defined. Before use, therefore, sealed Ni-MH cells should be recharged.

Main Applications:

- RTC-Backup
- Memory-Backup
- Sensor Network Supply

Quality – Made in Germany

- Manufactured on highly automated lines
- Direct replacement for Ni-Cd
- No memory effect
- 0% lead, 0% mercury, and 0 % cadmium
- All cells have built in safety vent for security in abuse conditions
- UL recognition under file BBET2.MH13654
- ISO 9000 certified for design and manufacture of rechargeable mass type cells and batteries.
Conformity to requirements of ISO 9001
- VARTA Microbattery is a leader of Ni-MH Button Cell technology and received several ecological and industry awards
- are in line with ROHS (in accordance to EU directive 2002/95/EC). They do not contain the hazardous substances Hg, Cd, Pb, Cr⁶⁺, PBBs, PBDEs, as in ROHS, with Cd <100 ppm and the others >1000 ppm



Electrical characteristics*:

Nominal Voltage:	1.2 V
Typical Capacity:	80 mAh
Maximum Discharge current:	140 mA cont.

*See cell datasheet for further details

Physical characteristics:

Diameter:	17.0 mm
Height:	6.8 ⁺⁰ _{-0.6} mm
Typical weight:	4.2 g
Length (L):	6.2 mm
Width (W):	3.0 mm x 0.2 mm

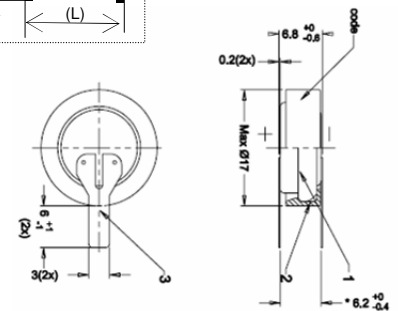
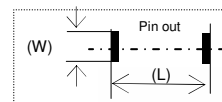

Designation System for Battery Assemblies

1 / V 80 H - SC ST

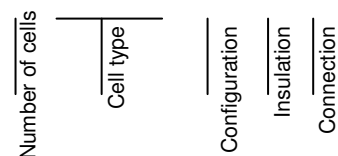

Rechargeable Nickel-Metal-Hydride Button Cells

55608 201 041 1 / V 80 H SC ST

PROPER USE AND HANDLING

Charging

Extended charging outside specified temperature ranges may have an adverse effect on cell life. Also permanent charging exceeding the limits of specified temperature ranges may reduce the battery life. The maximum life is achieved, when charging at an average temperature of +20 to +30°C.

Discharging

The specified temperature range is from -20 to +60°C on discharge. Repeated discharge at the extreme temperatures may affect battery life. In all application do not deep-discharge (< 0.6 V / cell) our Ni-MH cells and batteries.

Life Expectancy in Long-term use

Batteries are chemical products involving chemical reactions. Hence capacity and voltage will decrease over long time use as well as during long-term storage capacity and voltage will drop. Typically, a battery will last 5 years or 1000 IEC cycles, if used under recommended conditions and not overdischarged or overcharged. However, non-observance of recommended conditions concerning storage, charging, discharging, temperature and other factors during use can lead to shortened life expectancy of products and deterioration of performance.

Severe use applications

Short term use of Ni-MH batteries outside specified ranges maybe possible. Please consult us, if such a requirement exists.

DESIGN INFORMATION

- Charge at RT with 0.1CA / 0.2CA

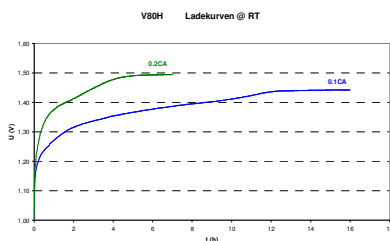

- Discharge at various loads

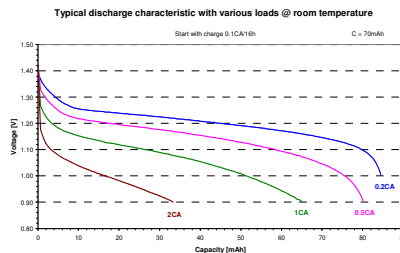

- Self discharge

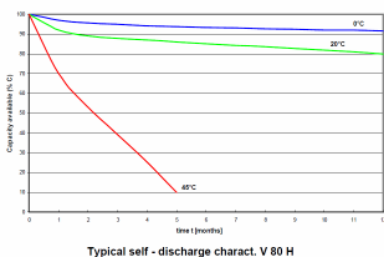

- Cycling with 0.3CA/0.2CA

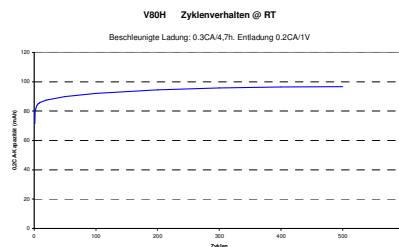

SAFETY GUIDELINES

- Keep out the reach of children. If swallowed, contact a physician at once
- Do not incinerate or mutilate, may burst or release toxic materials
- Do not short circuit, may cause burns
- Do not deep-discharge into reserve
- Do not solder on the battery directly (use our tagged versions)
- Restrict charging current and time to the recommended value
- Observe charging temperature: 0 to +65°C / +85°C
- Battery compartment should provide sufficient space for battery to expand in a case of abuse
- Either battery compartment or battery connector should have a design that makes it impossible to place the battery in reverse polarity
- Equipment intended for use by children should have tamper-proof battery compartment
- Battery of different electrochemical system, grades, or brands should not be mixed
- Battery disposal method should be in accordance with local and state regulations
- Please refer to our material safety datasheets as supporting documents

All data are related to cell characteristics.